

PCN7□-COM□



【形式構成】

PCN7□-COM□

使用圧着端子タイプ

無…Y形圧着端子
R…丸形圧着端子

仕様

201…20極 下段-COM/上段+COM
201P…20極 全極+コモン
201N…20極 全極-COM



【寸法図】

PCN7-COM□

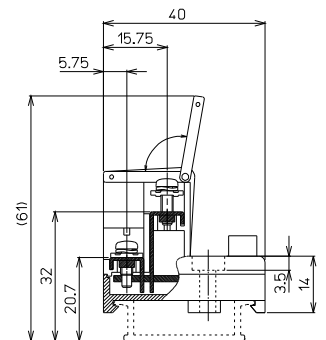
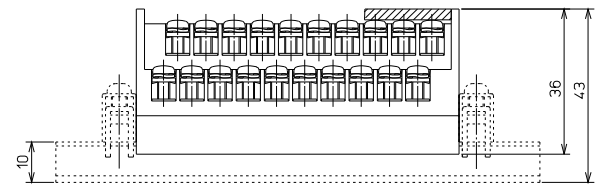
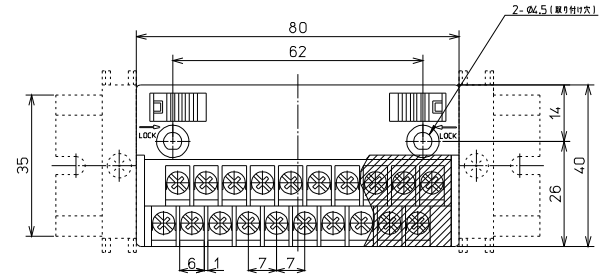

形式	海外規格	質量	標準価格(税抜)
PCN7-COM201	UL,TÜV	約72g	2,700円
PCN7-COM201P	UL,TÜV	約72g	2,700円
PCN7-COM201N	UL,TÜV	約72g	2,700円

【一般仕様】

定格絶縁電圧	AC DC125V
定格通電電流	10A
絶縁抵抗	100MΩ以上 DC500Vメガ
耐電圧	AC500V / 1分間
適合電線	1.25mm ² / MAX
端子ネジ	PCN7 M3×9.5L PCN7R M3×7L
締付トルク	1.2N・m
周囲温度	-15℃~+60℃ (氷結又は結露しないこと)

適合圧着端子

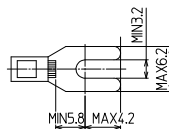

【記名板・結線図】

PCN7-COM201

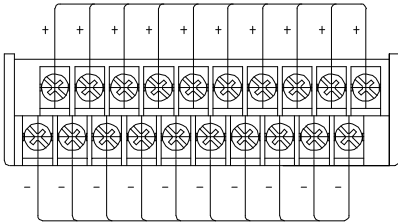
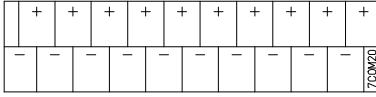

PCN7-COM201P

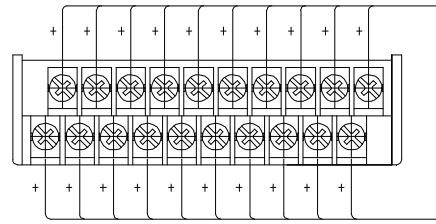
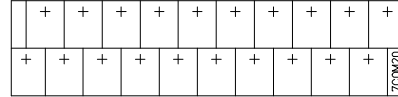

PCN7-COM201N

