

PCN□-COM□



【形式構成】

PCN□-COM□

結線方法

無…Y形圧着端子用
R…丸形圧着端子用

仕様

201…20極 下段-COM/上段+COM
202…40極 下段-COM/上段+COM
201P…20極 全極+コモン
201N…20極 全極-コモン

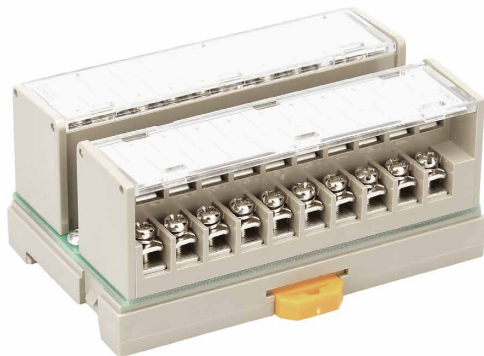

【寸法図】

PCN-COM201□

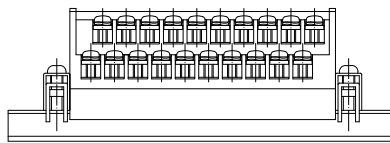
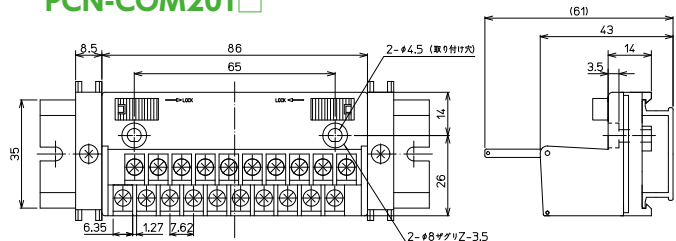

PCN-COM202

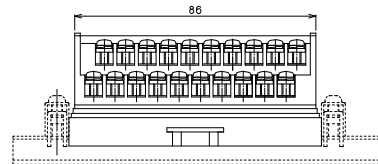
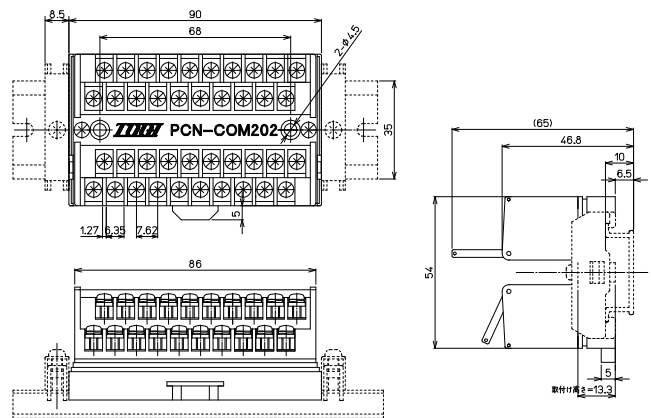

形 式	海外規格	質量	標準価格 (税抜)
PCN-COM201	UL,TÜV	約76g	2,760円
PCN-COM202	—	約134g	4,030円
PCN-COM201P	UL,TÜV	約76g	2,760円
PCN-COM201N	UL,TÜV	約77g	2,760円

【一般仕様】

定格絶縁電圧	AC DC125V
定格通電電流	10A
絶縁抵抗	100MΩ以上 DC500Vメガ
耐電圧	AC500V / 1分間
適合電線	1.25mm ² / MAX
端子ネジ	PCN M3×9.5L PCNR M3×7L
締付トルク	1.2N・m
周囲温度	-15℃~+60℃ (氷結又は結露しないこと)

適合圧着端子

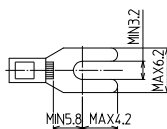

【記名板・結線図】

PCN-COM201

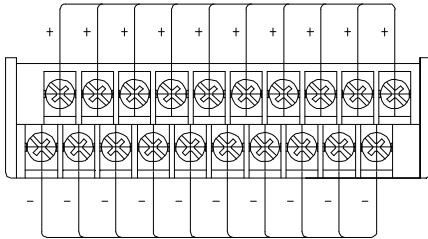
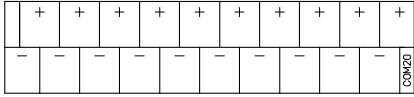

PCN-COM201P

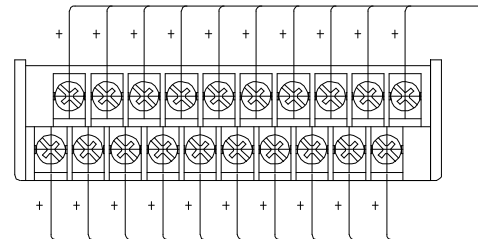
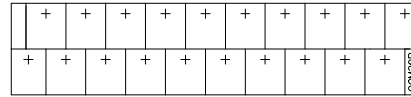

PCN-COM201N

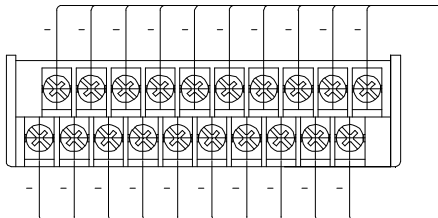
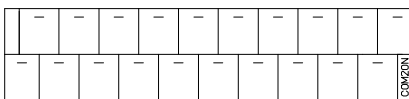

PCN-COM202

