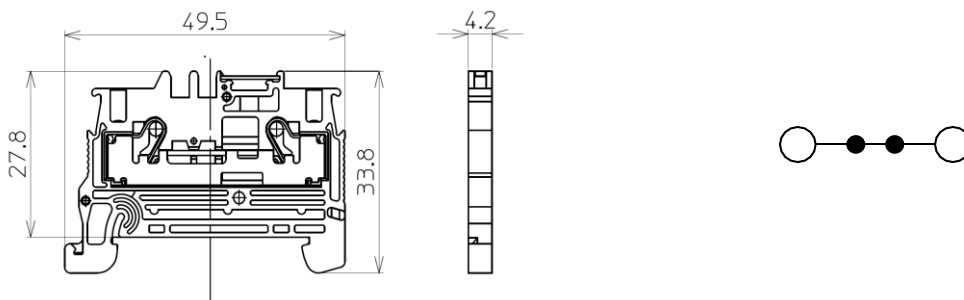

Spring-Lock type Terminal Block

VTX-2/2**TDGI TOYOGIKEN CO.,LTD.**

- Spring-Lock type
- 2.5mm²/24A/500V
- 4.2mm wide
- Easy to remove connected wire with a release button.
- No retightening is required.
- IEC/DIN35mm rail mount
- Insulation material:Nylon (UL94V-0)

**General Data**

Sales lot	100
Minimum order quantity	100
Weight per Piece	5.5g
Size (D:from top of the rail)	W 4.2mm x H 49.5mm x D 27.8mm
HS code	8536.90
Country of origin	Japan

Material

	Material	Flammability rating	Material group
Body	66Nylon	UL94V-0	I
Release Button	66Nylon	UL94V-0	III

Body Color and Part No.

 Gray	: VTX-2/2	 Red	: VTX-2/2R
 Blue	: VTX-2/2BL	 Orange	: VTX-2/2O
 Black	: VTX-2/2BK		



*Product appearance and specifications are subject to change without notice.

Spring-Lock type Terminal Block

VTX-2/2**TDG TOYOGIKEN CO.,LTD.****Specification**

Standard	IEC/EN	60947-7-1	
		TÜV Certificate No.	R50413013
	JIS	C 8201-7-1	
	NECA	C 2811	

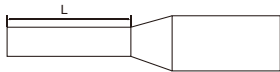
Rated voltage	IEC/JIS	500V	NECA	500V
Rated current	IEC/JIS	24A	NECA	24A
Withstand voltage	IEC/JIS	1890V	NECA	2500V
Rated cross-section	2.5mm ²			
Overvoltage category	Ⅲ			
Rated impulse withstand voltage	6kV			
Pollution degree	3			
IP code	IP2X			
Insulation resistance	200MΩ or more (DC500V)			
Ambient temperature	-25°C~+60°C (No freezing and condensations)			
Relative humidity	45%~85%			

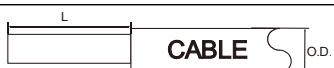
Applicable wire size	Cross section	L
Ferrule with plastic sleeve 	0.14mm ² -0.34mm ² 0.5mm ² -1.5mm ²	10mm 8mm
Stranded 	0.14mm ² -2.5mm ²	10mm-11mm
Solid 	Φ0.5mm ² -Φ1.6mm ²	10mm-11mm

*Stranded and Solid: Insulation Outer Diameter ≤Φ3.9mm

Approval

UL1059 / C22.2 No.158 File No. : E113585

		Use group[B, C]	Use group[D]
Rated voltage		300V	600V
Rated current		20A	5A
Wire range	Ferrule with plastic sleeve	AWG26-AWG16	
	Stranded	AWG26-AWG12	
	Solid	AWG26-AWG12	

Spring-Lock type Terminal Block

VTX-2/2**TDGI TOYOGIKEN CO.,LTD.****Accessory**

End plate (for insulating conductive part)	VTX-2/2E
End plate (for holding a nameplate)	VTX-2/2E1
Stopper	SDV-3, GTY18
Nameplate (top)	AM-10, AR-10
Nameplate (side)	AP-6.5, AR-6.5

Rail

Aluminum rail	DAV4-1000, DAV4-2000
	DAV5-1000, DAV5-2000
	DAV5S-1000, DAV5S-2000
	DAS4-1000, DAS4-2000
	DAS5-1000, DAS5-2000
Aluminum rail (Not Anodizing) *Short-time withstand current(1s): 4.2kA	DAV4-1000(NA), DAV4-2000(NA)
	DAV5-1000(NA), DAV5-2000(NA)

Spring-Lock type Terminal Block

VTX-2/2**TDGI TOYOGIKEN CO.,LTD.****Assembled Terminal Blocks**

- Factory-assembled and shipped

•Part No.

VTXL-2/2[Color]-□P

[Color]: BL=Blue, R=Red, O=Orange, BK=Black, Nothing=Gray

□: Number of Terminal blocks

Components

Terminal block	VTX-2/2[Color]
End plate	VTX-2/2E,VTX-2/2E1
Stopper	SDV-3
Nameplate	AR-10
Rail	DAV4

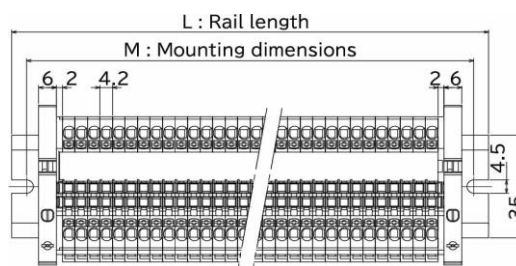





□P	L(mm)	M(mm)
1-2	40	30
3-6	60	50
7-11	80	70
12-16	100	90
17-21	120	110
22-25	140	130
26-30	160	150
31-35	180	170
36-40	200	190
41-45	220	210
46-49	240	230
50-54	260	250
55-59	280	270
60-64	300	290
65-68	320	310
69-73	340	330
74-78	360	350
79-83	380	370
84-87	400	390
88-92	420	410
93-97	440	430
98-102	460	450
103-106	480	470
107-111	500	490

□P	L(mm)	M(mm)
112-116	520	510
117-121	540	530
122-125	560	550
126-130	580	570
131-135	600	590
136-140	620	610
141-145	640	630
146-149	660	650
150-154	680	670
155-159	700	690
160-164	720	710
165-168	740	730
169-173	760	750
174-178	780	770
179-183	800	790
184-187	820	810
188-192	840	830
193-197	860	850
198-202	880	870
203-206	900	890
207-211	920	910
212-216	940	930
217-221	960	950
222-225	980	970
226-230	1000	990

Spring-Lock type Terminal Block

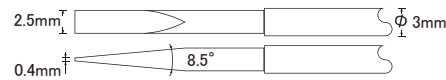
VTX-2/2**TOGI TOYOGIKEN CO.,LTD.****Tool****•Flat head screw driver**

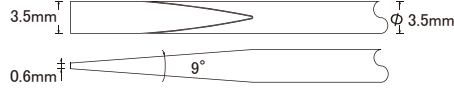
for VTX-1.5, VTX-2	VT5-0
for VTX-2.5, VTX-4, VTX-6	VT5-1
for VTX-10, VTX-16	VT5-2

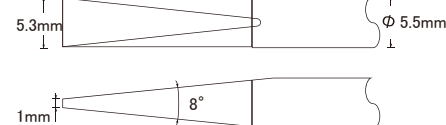
VT5-0 	
VT5-1 	
VT5-2 	

※If use screwdrivers other than the ones above, use the screwdrivers comply with DIN5264.

•Crimping Plier for Ferrules

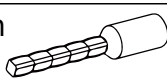
Part No.	Applicable wire range	Crimp form
TA-540	0.14mm ² ~ 16mm ²	square crimp form 
	AWG26 ~ AWG5	



Spring-Lock type Terminal Block

VTX-2/2**TOGI TOYOGIKEN CO.,LTD.****Ferrule**

Part No.	Cross section (mm ²)	Length (mm)	VTX/VTXW							
			1.5	2	2.5	4	6	10	16	
TA0.25-10YE		0.25	10	●	●					
TA0.25-12BU		0.25	12			●	●			
TA0.34-10TQ		0.34	10	●	●					
TA0.34-12TQ		0.34	12			●	●			
TA0.5-8WH		0.5	8	●	●					
TA0.5-8WH-GB	GB	0.5	8		●					
TA0.5-10WH-GB	GB	0.5	10			●	●			
TA0.5-10WH		0.5	10			●	●			
TAW0.5-10WH	W	0.5	10			●	●			
TA0.5-10OG		0.5	10			●	●			
TA0.5-12WH		0.5	12					●		
TA0.75-8GY		0.75	8	●	●					
TA0.75-8GY-GB	GB	0.75	8		●					
TA0.75-10WH		0.75	10			●	●			
TA0.75-10GY-GB	GB	0.75	10			●	●			
TA0.75-10GY		0.75	10			●	●			
TAW0.75-10GY	W	0.75	10				●			
TA0.75-12GY		0.75	12					●		
TA1-8RD		1	8		●					
TA1-10YE		1	10			●	●			
TA1-10RD		1	10			●	●			
TA1-10RD-GB	GB	1	10			●	●			
TAW1-10RD	W	1	10				●			
TA1-12RD		1	12					●		
TA1.5-8BK		1.5	8		●					
TA1.5-10BK-GB	GB	1.5	10			●	●			
TA1.5-10BK		1.5	10			●	●			
TA1.5-10RD		1.5	10			●	●			
TA1.5-12BK		1.5	12					●		
TAW1.5-12BK	W	1.5	12					●		
TA2.5-10BU		2.5	10			●	●			
TA2.5-12BU		2.5	12					●		
TA4-10GY		4	10				●			
TA4-12GY		4	12					●		
TA4-18GY		4	18						●	●
TA6-12YE		6	12					●		
TA6-12BK		6	12					●		
TA6-18YE		6	18						●	●
TA10-18RD		10	18						●	●
TA16-18BU		16	18							●

Spring-Lock type Terminal Block

VTX-2/2**TDGI TOYOGIKEN CO.,LTD.****Short bar**

Part No.				Number of poles	Rated voltage (V)	Rated current (A)	Compatible Series
Black	Red	Gray	Blue				
BBX1.5-2	RBX1.5-2	GBX1.5-2	BLBX1.5-2	2	500	17.5	VTX(W)-1.5
BBX1.5-3	RBX1.5-3	GBX1.5-3	BLBX1.5-3	3			
BBX1.5-4	RBX1.5-4	GBX1.5-4	BLBX1.5-4	4			
BBX1.5-5	RBX1.5-5	GBX1.5-5	BLBX1.5-5	5			
BBX1.5-10	RBX1.5-10	GBX1.5-10	BLBX1.5-10	10			
BBX1.5-20	RBX1.5-20	GBX1.5-20	BLBX1.5-20	20			
BBX2-2	RBX2-2	GBX2-2	BLBX2-2	2	500	24	VTX(W)-2
BBX2-3	RBX2-3	GBX2-3	BLBX2-3	3			
BBX2-4	RBX2-4	GBX2-4	BLBX2-4	4			
BBX2-5	RBX2-5	GBX2-5	BLBX2-5	5			
BBX2-10	RBX2-10	GBX2-10	BLBX2-10	10			
BBX2-20	RBX2-20	GBX2-20	BLBX2-20	20			
BBX2.5-2	RBX2.5-2	GBX2.5-2	BLBX2.5-2	2	800	24	VTX(W)-2.5
BBX2.5-3	RBX2.5-3	GBX2.5-3	BLBX2.5-3	3			
BBX2.5-4	RBX2.5-4	GBX2.5-4	BLBX2.5-4	4			
BBX2.5-5	RBX2.5-5	GBX2.5-5	BLBX2.5-5	5			
BBX2.5-10	RBX2.5-10	GBX2.5-10	BLBX2.5-10	10			
BBX2.5-20	RBX2.5-20	GBX2.5-20	BLBX2.5-20	20			
BBX4-2	RBX4-2	GBX4-2	BLBX4-2	2	800	32	VTX(W)-4
BBX4-3	RBX4-3	GBX4-3	BLBX4-3	3			
BBX4-4	RBX4-4	GBX4-4	BLBX4-4	4			
BBX4-5	RBX4-5	GBX4-5	BLBX4-5	5			
BBX4-10	RBX4-10	GBX4-10	BLBX4-10	10			
BBX4-20	RBX4-20	GBX4-20	BLBX4-20	20			
BBX6-2	RBX6-2	GBX6-2	BLBX6-2	2	1000	41	VTX-6
BBX6-3	RBX6-3	GBX6-3	BLBX6-3	3			
BBX6-4	RBX6-4	GBX6-4	BLBX6-4	4			
BBX6-5	RBX6-5	GBX6-5	BLBX6-5	5			
BBX6-6	RBX6-6	GBX6-6	BLBX6-6	6			
BBX6-10	RBX6-10	GBX6-10	BLBX6-10	10			
BBX10-2	RBX10-2	GBX10-2	BLBX10-2	2	1000	57	VTX-10
BBX10-5	RBX10-5	GBX10-5	BLBX10-5	5			
BBX16-2	RBX16-2	GBX16-2	BLBX16-2	2	1000	76	VTX-16

•Position-skipping

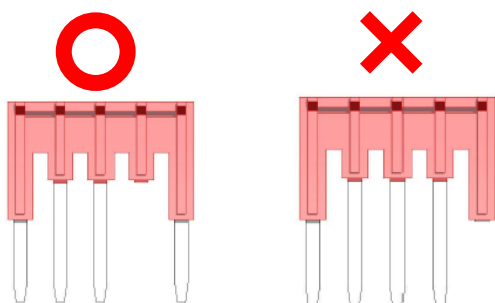

- Please be careful not to break resin parts of a short bar during processing.
- Do not cut bars at the ends.
- Rated voltage 600V when skipping poles at VTX(W)-2.5, VTX(W)-4 and VTX-6.